

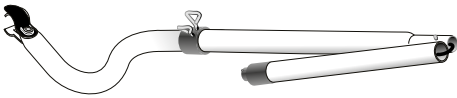









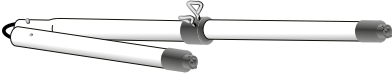





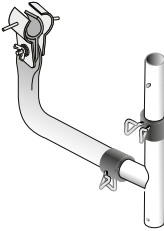



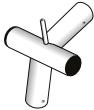

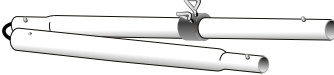

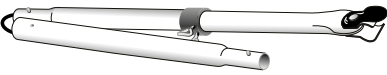
A			x 2
AM			x 1
B			x 3
CH			x 1
CMB			x 1
CMF			x 2
CV			x 1
E			x 2
H			x 2
MB			x 1
V			x 2
V1			x 2



1

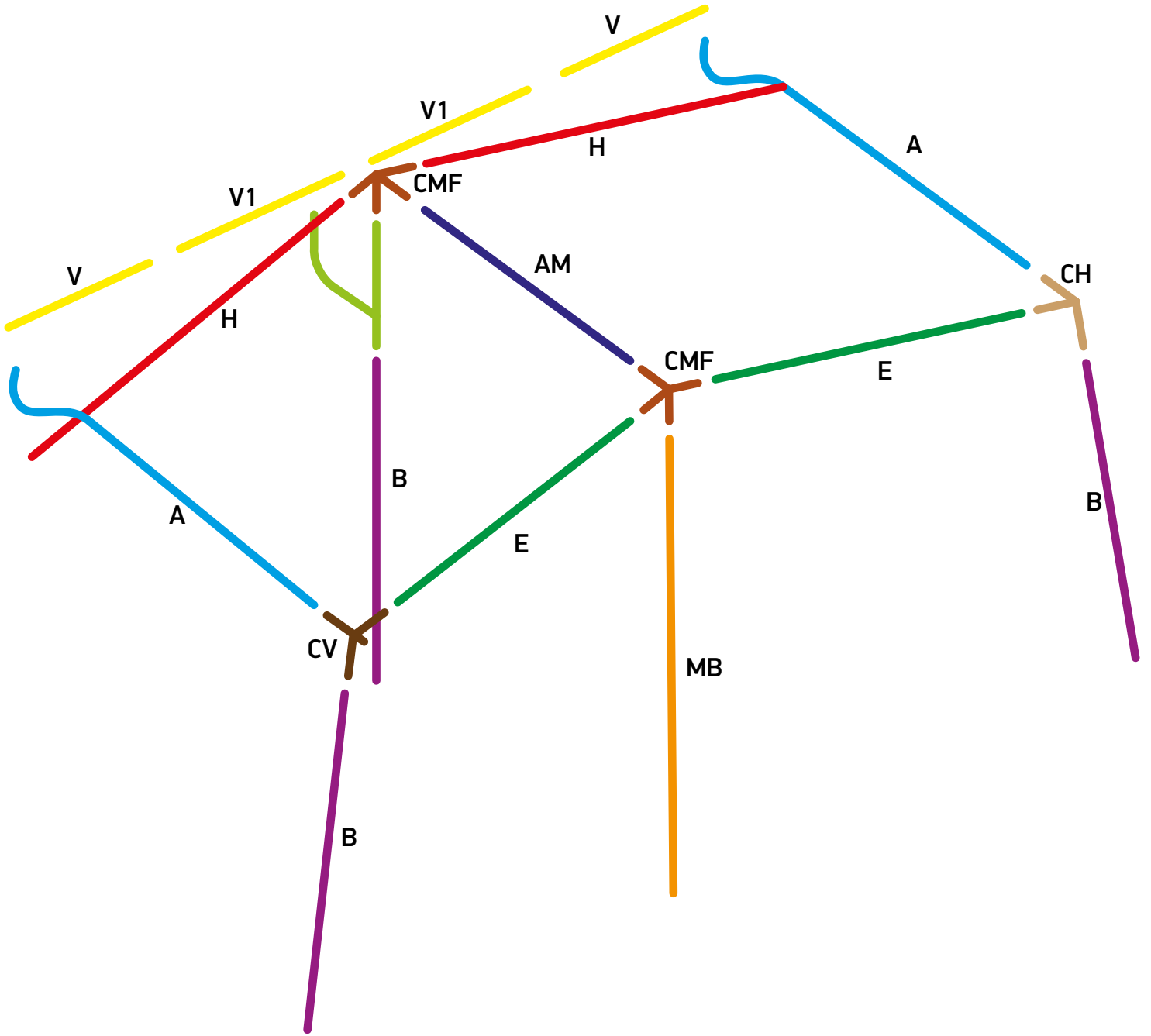
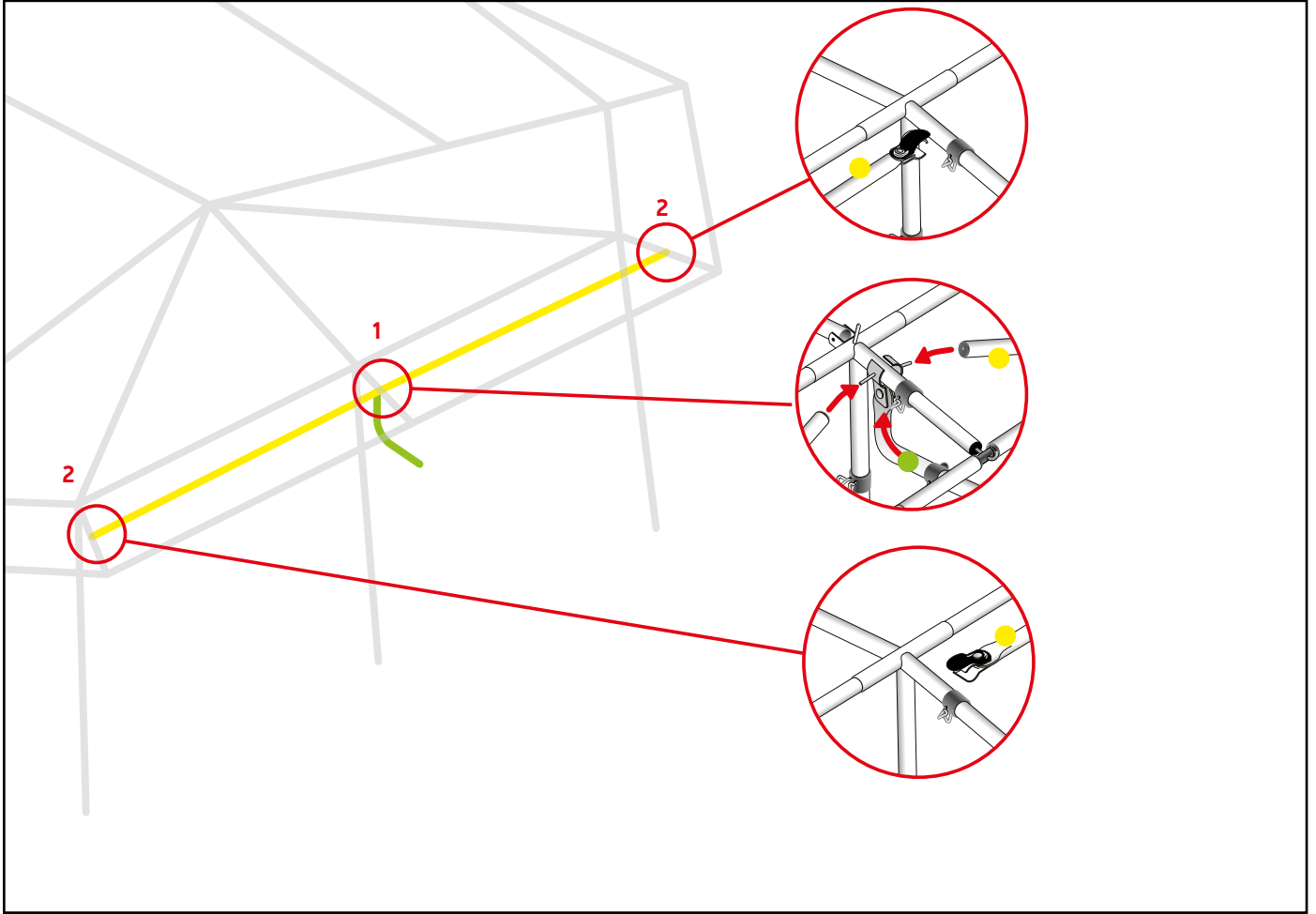

2

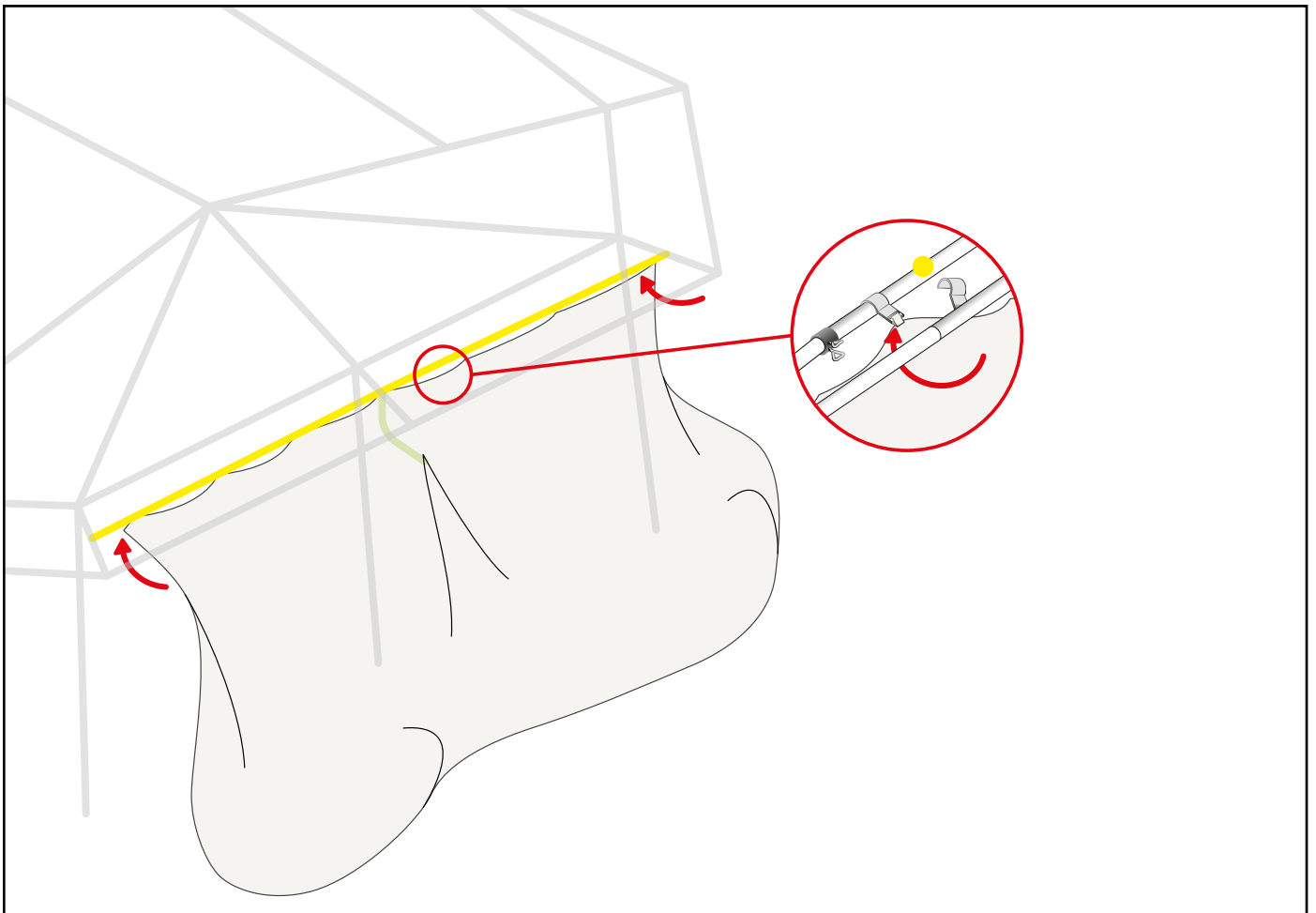

3

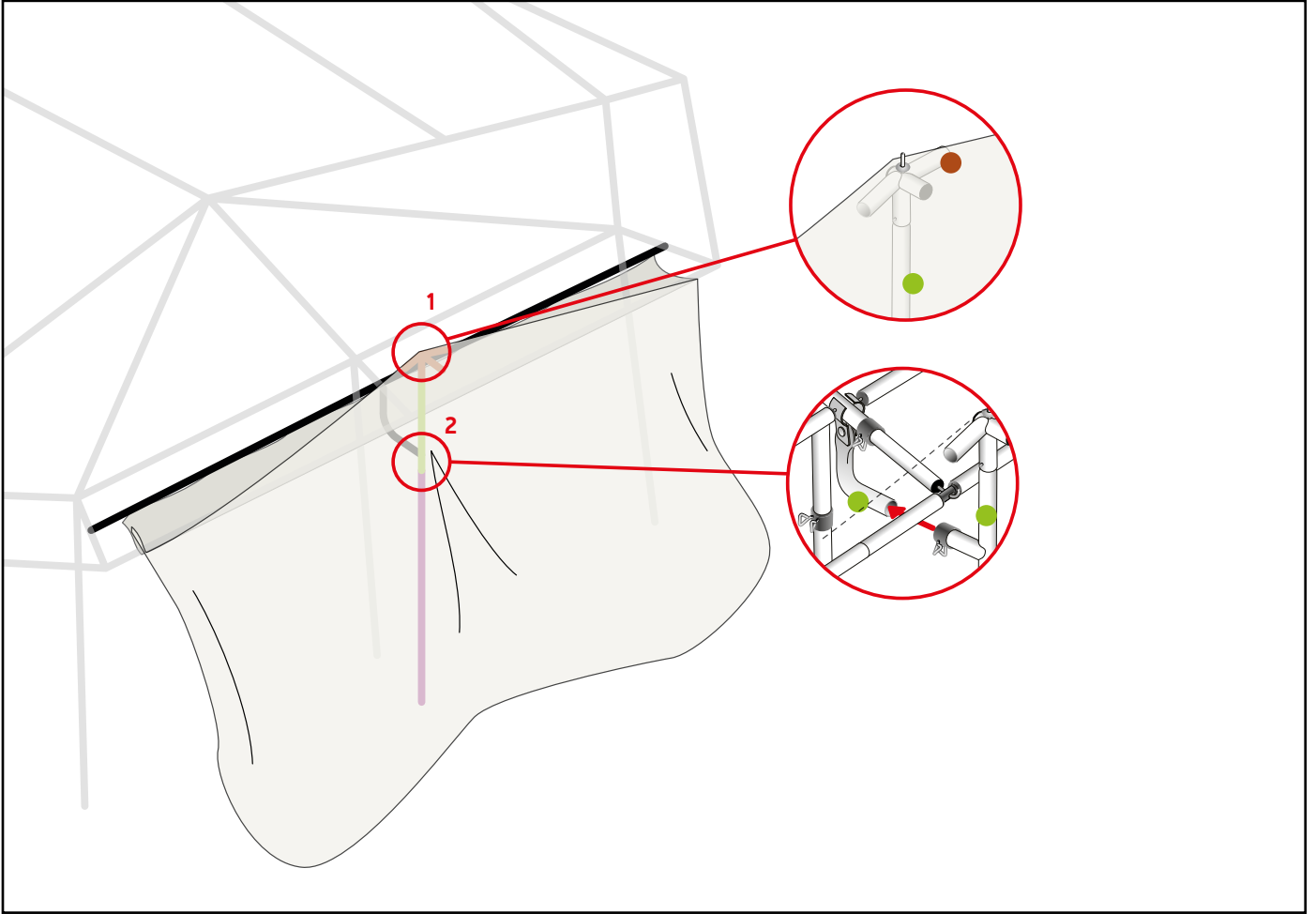

4

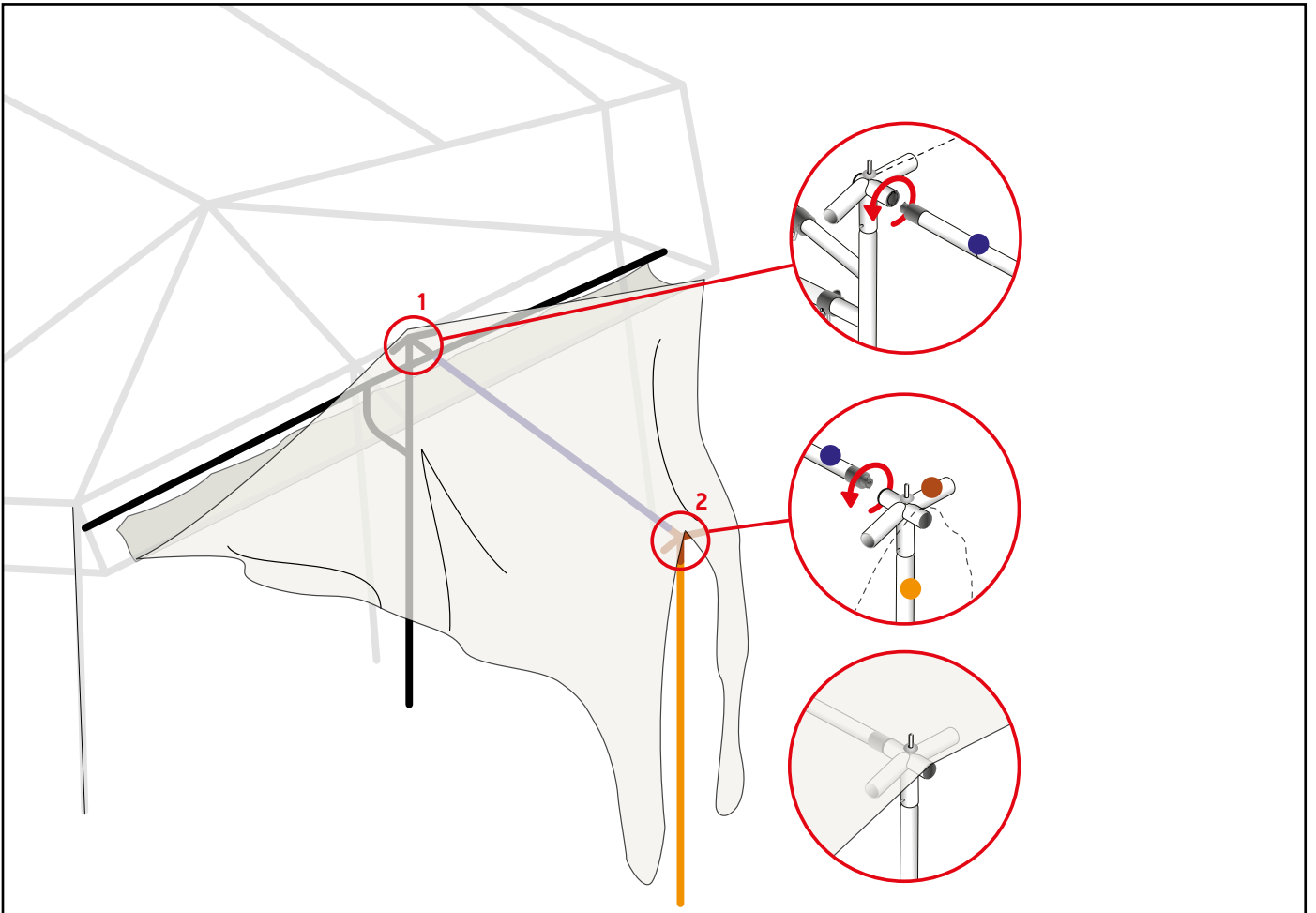

5

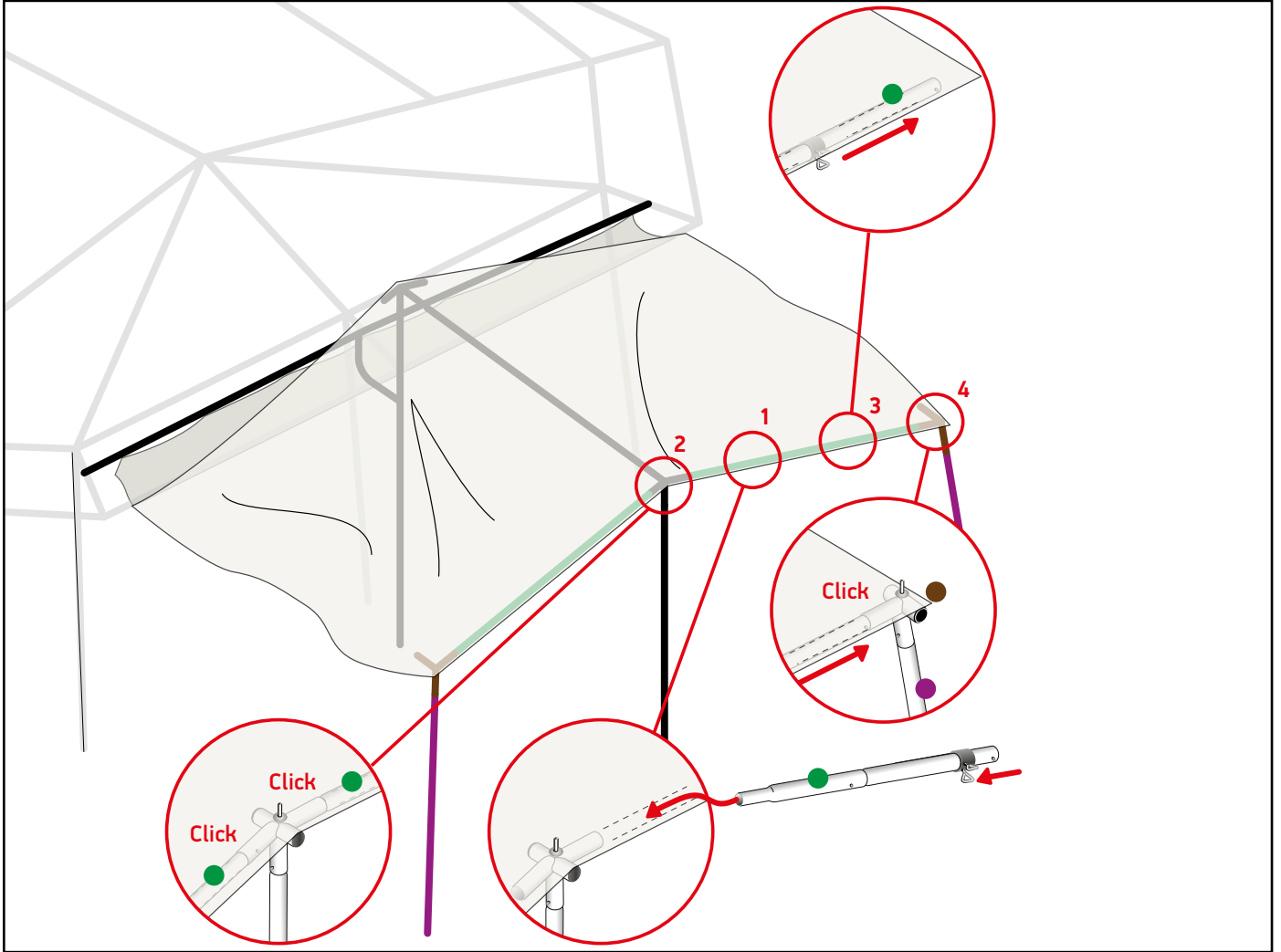

6

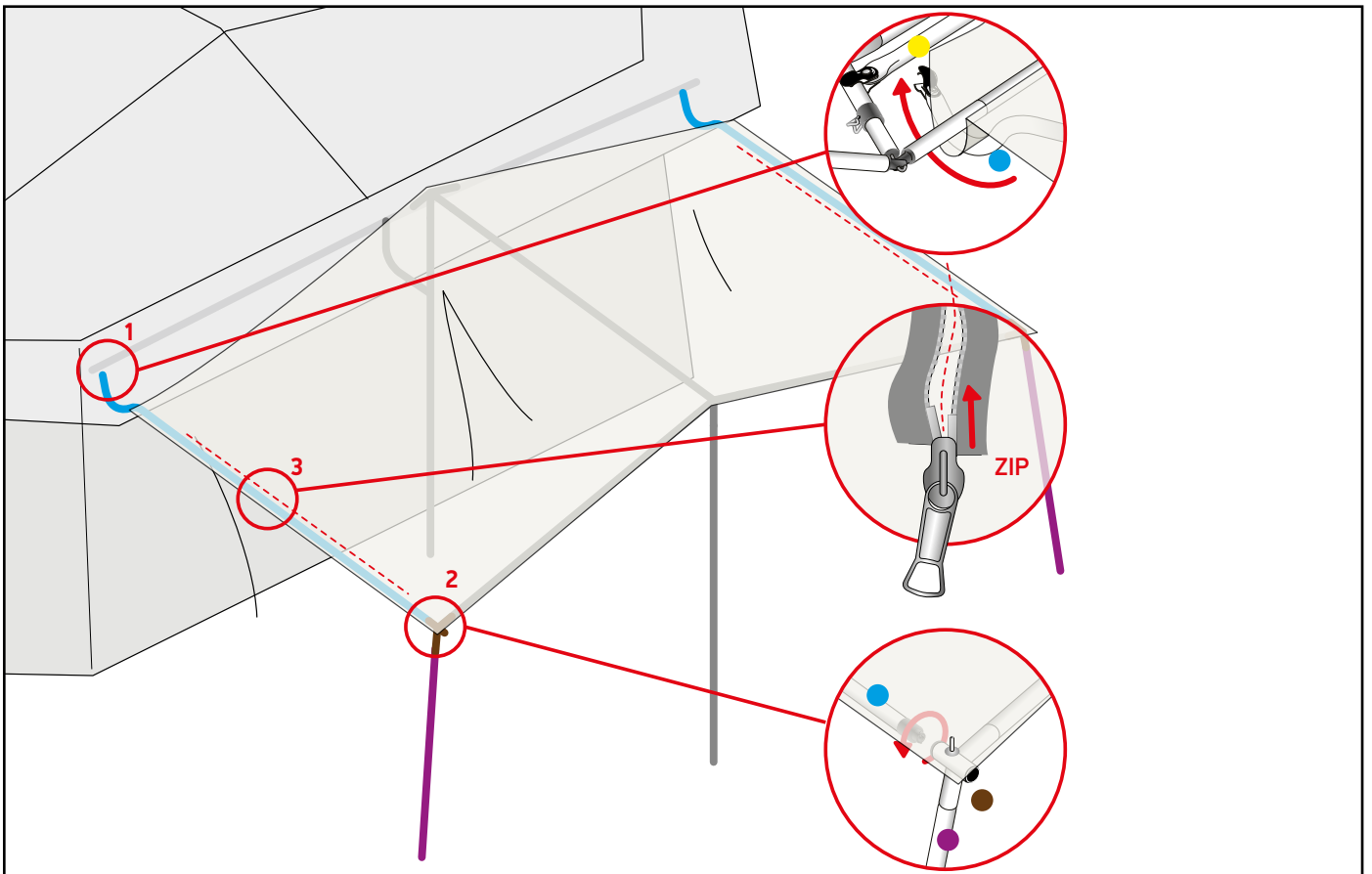

7

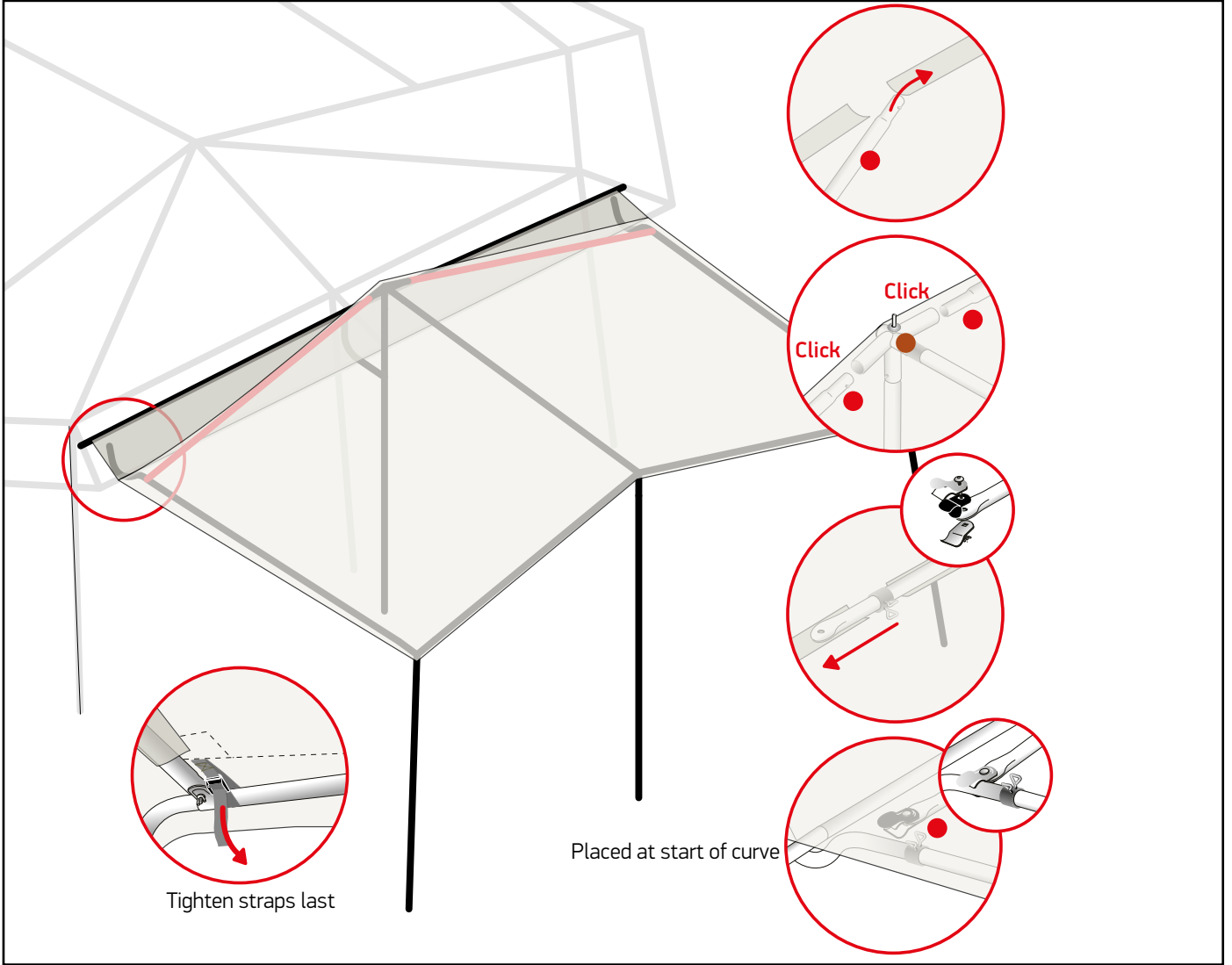

8

